



# SCUBAPRO BCS MANUAL

Congratulations on purchasing a SCUBAPRO Buoyancy compensator (BC) and welcome to SCUBAPRO. We are confident that you will enjoy extraordinary performance from our BC, designed and manufactured using the most advanced technology.

We thank you for choosing SCUBAPRO and wish you a future of safe dives and underwater enjoyment!

## TABLE OF CONTENTS

<b>1. IMPORTANT WARNINGS</b> .....	<b>2</b>
<b>2. CE CERTIFICATION</b> .....	<b>2</b>
2.1 EN 250: 2000 norm regulations and what they mean .....	3
2.2 Definition of 'SCUBA' according to EN 250: 2000 .....	3
2.3 Limitations provided by EN 250: 2000 .....	3
<b>3. IMPORTANT CAUTIONS</b> .....	<b>3</b>
<b>4. GENERAL INFORMATION</b> .....	<b>4</b>
<b>5. INITIAL SET UP</b> .....	<b>4</b>
5.1 Cylinder strap set up and attachment (single cylinder) super cinch q.a. (quick adjust.) (some models).....	5
5.2 Quick release belt backpack: Adjustment and attachment (single tank) (some models).....	6
<b>6. SET UP FOR DOUBLE SCUBA CYLINDERS (P/N 20.040.000)</b> <b>(some models: see models features)</b> .....	<b>7</b>
<b>7. BALLASTING SYSTEM</b> .....	<b>7</b>
7.1 Standard weight belt.....	7
7.2 Integrated Weight Pocket System (BW) (proprietary) (some models: see models features) .....	7
7.3 Back counter Weight Pockets (some models: see model features).....	8
<b>8. VALVE SET UP</b> .....	<b>9</b>
<b>9. OPERATION</b> .....	<b>9</b>
<b>10. BC HARNESS ADJUSTMENT - GENERAL FEATURES</b> .....	<b>11</b>
<b>11. BC EXAMINATION AND PROCEDURES</b> .....	<b>12</b>
<b>12. STORAGE</b> .....	<b>13</b>
<b>13. GENERAL SPECIFICATIONS</b> .....	<b>13</b>
<b>14. T-BLACK</b> .....	<b>14</b>
<b>15. T-FORCE</b> .....	<b>15</b>
<b>16. T-SPORT PLUS</b> .....	<b>16</b>
<b>17. T-ONE</b> .....	<b>17</b>
<b>18. X-FORCE</b> .....	<b>18</b>
<b>19. GEO</b> .....	<b>19</b>
<b>20. MASTER JACKET</b> .....	<b>20</b>
<b>21. KNIGHTHAWK LADYHAWK SEAHAWK LITEHAWK</b> .....	<b>22</b>
<b>22. CLASSIC UNLIMITED - CLASSIC EXPLORER</b> .....	<b>24</b>
<b>23. BELLA BC</b> .....	<b>25</b>
<b>24. EQUATOR</b> .....	<b>26</b>

## 1. IMPORTANT WARNINGS

### WARNING

This manual must be read and understood entirely before using the product. It is advised that you keep this manual in your possession during the entire life of your BC. FAILURE TO READ, UNDERSTAND, AND FOLLOW THE PRECAUTIONS LISTED IN THIS MANUAL COULD RESULT IN SERIOUS INJURY OR DEATH.

### WARNING

When diving you must follow the rules and apply the skills taught by a recognized scuba diving certification agency. Before taking part in any diving activity, it is mandatory to have successfully completed a scuba diving course covering both theoretical and technical aspects of diving.

### WARNING

This instruction manual does not replace a diving instruction course!

## 2. CE CERTIFICATION

All SCUBAPRO BCs described in this manual have obtained the CE certification issued by a notified body according to European directive 89/686/EEC. Certification tests have been conducted according to the specifications set by the said directive, regulating the conditions for the release on the market and the fundamental safety requirement for Personal Protective Equipment (PPE). The CE mark denotes compliance with the fundamental requirements for health and safety. The number next to the CE marking is the identification code for the notified body yearly controlling production compliance with regulations, as per Art. 11A ED 89/686/EEC.

The BCs described in this manual have obtained the CE certification according the following European norms:

**EN 250: 2000** for body harness that provides divers with a device for fixing the tank to the body : it has not to be used deeper than 50 m (164 feet).

**EN 12628 (Master Jacket only)** for CBRD (Combined Buoyancy Rescue Device) that provides divers with a buoyancy control device that also guarantees a head up position of the wearer at the surface.

**EN 1809: 1997** European norm for jacket that provides divers with a buoyancy control device but does not guarantee a head up position of the wearer at the surface.

Each BC model has an indication of the relevant EU certification obtained.

### WARNING

**THIS BC IS NOT A LIFEJACKET.**

Emergency face up floatation may not be provided for all wearers and in all conditions (except for Master Jacket).

### WARNING

Ensure you have fully understood the jacket's function and features and adjust the straps appropriately before diving. If in doubt, ask your official SCUBAPRO dealer for help.

**WARNING**

This BC is not a breathing device.  
Never breathe from the BC.

Your BC may contain gas residue, liquid, or contamination that may result in injury or death if inhaled.

**WARNING**

In accordance with European standards, our BCs can only be considered certified where all components are present, as per the original SCUBAPRO configuration, including the low pressure hose supplied.

Any variation of the original configuration invalidates conformity to European certification standards.

**2.1 EN 250: 2000 norm regulations and what they mean**

The requirements and tests defined by the EN 250: 2000 standard aim to ensure a minimum safety level for the operation of underwater breathing equipment. In Europe, the EN 250: 2000 norm defines the minimum technical standards of acceptance for recreational diving regulators. All SCUBAPRO regulators have successfully passed the certification test required by this regulation.

**2.2 Definition of 'SCUBA' according to EN 250: 2000**

This regulation defines a SCUBA unit as a self-contained open-circuit underwater breathing apparatus. A SCUBA unit can be composed of component groups. During use, the minimum required component groups are elements a) to e) of the following list:

- a. cylinder(s) with valve(s);
- b. demand regulator(s);
- c. safety device(s);
- d. face mask: complete mouthpiece or half-mask for diving or complete mask;
- e. carrying system.

**2.3 Limitations provided by EN 250: 2000**

The SCUBA unit can be comprised of separate components such as: cylinder(s), regulator(s), pressure gauge. The SCUBAPRO BCs described in this manual can be used with SCUBA components units certified according to directive 89/686/EEC and EN 250: 2000 norm. The air contained in the cylinder must comply with the requirements for breathable air defined by EN 12021 norm. The maximum operating depth is 50 meters (164 ft.) however divers must conform to the limits set by local regulations in force at the diving location.

**3. IMPORTANT CAUTIONS**

For your protection while using SCUBAPRO life support equipment, we call your attention to the following:

1. Use the equipment according to the instructions contained in this manual and only after having completely read and understood all instructions and warnings.
2. Use of the equipment is limited to the uses described in this manual or for applications approved in writing by SCUBAPRO.
3. Cylinders must only be filled with atmospheric compressed air, according to the EN 12021 norm. Should moisture be present in the cylinder, beside causing corrosion of the cylinder, it may cause freezing and subsequent malfunction of the regulator during dives carried

out in low temperature conditions (lower than 10°C (50°F)). Cylinders must be transported according to local rules provided for the transport of dangerous goods. Cylinder use is subjected to the laws regulating the use of gases and compressed air.

4. Equipment must be serviced by qualified personnel at the prescribed intervals. Repairs and maintenance must be carried out by an Authorized SCUBAPRO Dealer service facility and with the exclusive use of original SCUBAPRO spare parts.
5. Should the equipment be serviced or repaired without complying with procedures approved by SCUBAPRO or by untrained personnel or not certified by SCUBAPRO, or should it be used in ways and for purposes other than specifically designated, liability for the correct and safe function of the equipment transfers to the owner/user.
6. The content of this manual is based upon the latest information available at the time of going to print. SCUBAPRO reserves the right to make changes at any time.
7. All dives must be planned and carried out so that at the end of the dive the diver will still have a reasonable reserve of air for emergency use. The suggested amount is usually 50 bars (725 psi).

SCUBAPRO refuses all responsibility for damages caused by non-compliance with the instructions contained in this manual. These instructions do not extend the warranty or the responsibilities stated by SCUBAPRO terms of sales and delivery.



**WARNING**

Always perform a pre-dive and post-dive inspection of the BC.

**4. GENERAL INFORMATION**

**Primary purpose of the Buoyancy Compensator**

The primary purpose of a Buoyancy Compensator is to make you more comfortable by enabling you to maintain neutral buoyancy at depth.

You are neutrally buoyant when you maintain a specific depth without expending significant physical effort to prevent an ascent or descent from that depth.



**WARNING**

Do not use your BC as an assist or “lift bag” for bringing objects to the surface. These objects may be lost during the ascent, creating a sudden increase in buoyancy and loss of buoyancy control.

**5. INITIAL SET UP**

**Low Pressure (LP) hose**

Connect the low pressure (LP) hose of the Power Inflation Valve or A.I.R. 2 to an unused LP port of the first stage, **that must have the same thread** (fig. 1).

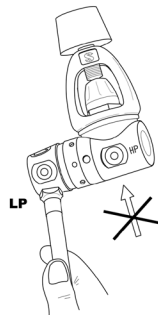

fig. 1

## WARNING

Do not attach a L.P. hose to a SCUBA regulator high pressure (HP) port or to an air supply with pressure in excess of 200 psi (13.8 bar). This may result in damage or explosive failure of the Inflation Valve or Low pressure Hose, which could result in injury or death.

### 5.1 Cylinder strap set up and attachment (single cylinder) super cinch q.a. (quick adjust.) (some models)

The SCUBAPRO Super Cinch Q.A. cylinder strap allows you to easily fasten your BC to any single SCUBA cylinder.

Set up for a single SCUBA cylinder must be accomplished following these steps:

1. Wet the webbing of the Super Cinch Q.A. cylinder strap prior to tightening. Wrap the Super Cinch Q.A. (W1) strap (fig. 2 – 1) around the SCUBA cylinder and insert the end of the stainless steel buckle (B) into the trapezoidal “D” ring (DR1) (fig. 2 – 1). Position the SCUBA cylinder so that the cavity (S) of the back plate corresponds to the cylinder shoulder (fig. 2 – 2) with the lever (B) close to the back pack (BP) (fig. 2 – 3). The cylinder locator strap (L) (fig. 2 – 2), on the top of the back plate, encircling the valve neck of the cylinder, prevents the back pack strap assy from sliding down, while connecting and tightening the Super Cinch Q.A. Once correctly adjusted, it helps to easily and consistently find the correct position.
2. Close the buckle (C) (fig. 2 – 3). If the webbing strap is too tight to close or too loose to grab the SCUBA cylinder, open the velcro fastener on the webbing and readjust the length of the Super Cinch Q.A. (W1) webbing (fig. 2 – 1). For extra safety, slide the loop (SL) (fig. 2 – 1) around the webbing end (T). With SCUBA cylinder in place, lift the assembly by the back pack handle and shake firmly to check for secure fastening. Try to move the backpack up and down on the SCUBA cylinder. If there is movement, the band is not tight enough.

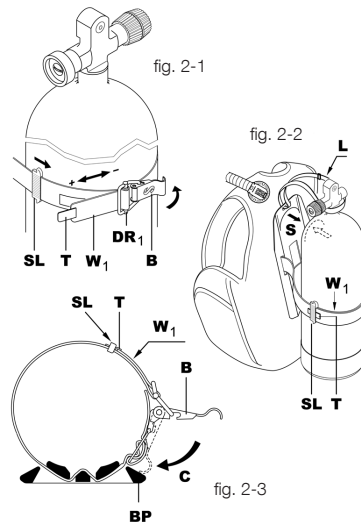

## 5.2 Quick release belt backpack: Adjustment and attachment (single tank) (some models)

The SCUBAPRO® quick-release belt lets you quickly release any single tank from the BC vest. It must be installed as follows:

- 1) Rotate the buckle until it snaps into the open position. Slide the strap around the plastic buckle as shown in the figure (Fig. 2-4), wet the strap before clamping it in place on the tank, and adjust the length (Fig. 2-7).
- 2) If the BC has a hard backplate, place the cavity (S) of the backplate on the shoulder of the tank (Fig. 2-6) and then fasten the strap (Fig. 2-5 and 2-7) of the quick-release belt (W1) around the tank.

On BCs with hard backplates, the safety strap (L) (Fig. 2 – 6) is fastened at the top of the backplate to prevent the BC from slipping downward while the strap is fastened and closed. Once adjusted correctly, it helps relocate the right position for the tank on the BC in an easy, repetitive way.

- 3) Close the buckle (C) (Fig. 2 – 7). If the strap is too tight or too loose, open the Velcro and the buckle to readjust the length of the strap (Fig. 2-5) of the quick-release belt (W1). For added safety, slide the loop (SL) (Fig. 2-5) around the strap end (T). In BCs with a hard backplate, with the tank mounted to the BC you can lift the entire unit using the handle integrated into the backplate.

Shake the unit to ensure the tank is properly fastened.

In BCs without a hard backplate, there is a second Velcro strap that allows you to easily position the tank to prevent unwanted shifting during the dive.

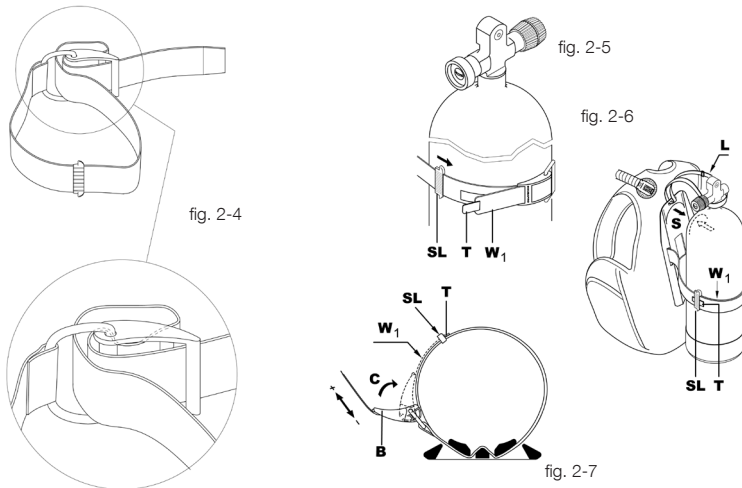

### WARNING

Soak the webbing of the SCUBA air cylinder strap and then tighten prior to each use of the BC. Webbing may stretch when initially exposed to water. Failure to soak the webbing may allow the cylinder strap to loosen around the SCUBA air cylinder. This could result in injury or death.

## 6. SET UP FOR DOUBLE SCUBA CYLINDERS (P/N 20.040.000) (SOME MODELS: SEE MODELS FEATURES)

SCUBAPRO offers a system to connect two tanks with an adjustable belt system, that allows to easily fasten and remove your BC from the double tanks (fig. 3).

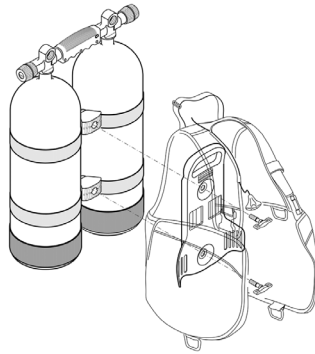

fig. 3

## 7. BALLASTING SYSTEM

The total weight must be calculated and tested in order to maintain a neutral buoyancy since you change depth during the dive, by simply adding or releasing the correct amount of air. The SCUBAPRO BC has been designed for three ballasting systems, based on the use of the 'Ecoweight' (soft sealed weight, patented by SCUBAPRO) developed to improve comfort, to reduce wear of the pockets and to protect the environment as well.

### 7.1 Standard weight belt

It is the traditional harness weight belt, separate from the BC.

### 7.2 Integrated Weight Pocket System (BW) (proprietary) (some models: see models features) (fig. 4)

These removable pockets are inserted in the BC compartments (fig. 4-3) held in position by the buckle (fig. 4-4) with the strap pulled by the "D" ring: in case of need, by disengaging the buckle (fig. 4-5, 4-6) it is possible whether to release the weights for emergency or, simply, to transfer the weight pocket to the boat, at the end of the dive.

See models features for maximum acceptable weight.

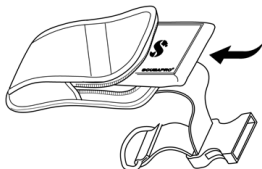

fig. 4-1

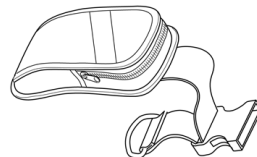

fig. 4-2

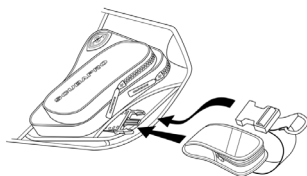

fig. 4-3



fig. 4-4



fig. 4-5

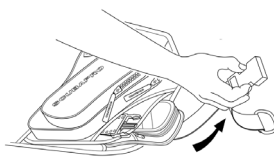

fig. 4-6

**⚠ WARNING**

The Ecoweight (fig. 4-1) and Removable Pocket (fig. 4-2) must be perfectly secured with the buckles fully and correctly engaged (fig. 4-4) : the loss of the pocket during diving causes positive buoyancy and uncontrolled ascent that could result in injury or death.

**⚠ WARNING**

Practice fastening and releasing the weight pockets several times before diving.

**7.3 Back counter Weight Pockets (some models: see model features)**

Top of the range SCUBAPRO BCs offer two counter weight pockets (fig. 5-CP<sub>1</sub>).

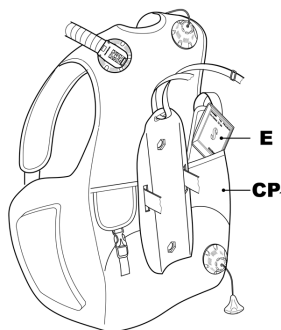

fig. 5

## **⚠ WARNING**

**Back counter weights are not designed to be released in an emergency. Failure to create adequate positive buoyancy in an emergency situation may result in injury or death. The user of the BC must configure the entire diving system in a manner that provides the means for rapidly and easily creating positive buoyancy as an aid for emergency ascent.**

See models features for maximum acceptable weight.

## 8. VALVE SET UP

SCUBAPRO BCs are completed by the BPI System (Balance Power Inflator).

The BPI, connected to the tank/regulator, makes it possible to control buoyancy in the water (inflation/deflation of the BC) by using inflate and deflate buttons.

Alternatively, users can assemble the AIR2 system.

### **Connecting the BPI and/or AIR 2**

The Power Inflation Valve allows you to inflate your BC using air from your SCUBA cylinder. Its LP hose, threaded on a LP port of the first stage regulator, is connected to the Power Inflation Valve by the Quick Disconnect Coupling that works with the air on or off.

To attach the Quick Disconnect Coupling (fig. 6 - C):

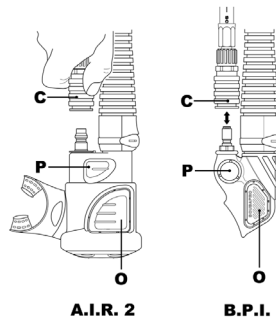

fig. 6

1. Make sure that both fittings are free of contamination prior to mating them together.
2. Pull back the collar of the Quick Disconnect Coupling, while pushing the hose firmly onto the fitting found on the power inflation valve.
3. Release the collar when the coupling is fully seated on the plug. Pull gently but firmly on the hose to check for a secure connection.
4. To disconnect, pull the Quick Disconnect Coupling collar back and disengage the LP hose from the plug.

## **⚠ WARNING**

**Keep water out of the inflatable aircell of the BC. Repeated use of the oral valve or the Overpressure Valve may allow water inside the BC, reducing the amount of buoyancy provided by the BC. This could result in injury or death. Drain all water out of the BC prior to every use.**

## 9. OPERATION

### **Inflating the BC with the Power Inflation Valve (on BPI and/or AIR2)**

To inflate the BC, press the Power Inflation Valve Button (fig. 6-P). Air should enter the BC. For better control during inflation use short bursts of air by repeatedly pressing and releasing the PIV button.

**Inflating the BC with the Oral Valve (on BPI and/or AIR 2)**

The Oral Valve is found on the end of the airway. It allows you to inflate your BC with your exhaled breath. Use of this valve for inflation is recommended on the surface, or on land prior to diving. It may be used when you cannot, or do not wish to add air to the BC with the Power Inflation Valve.

1. First exhale a small amount of air into the mouthpiece of the valve to purge any water that may be trapped there.
2. With the same breath, continue to exhale while deeply depressing the Oral Inflation Valve Button (fig. 6 - O).
3. Release the Oral Valve Button when you inhale fresh air.
4. Repeat steps 2 and 3 until the desired amount of buoyancy is reached.

**Deflating the BC with the Manual Dump Valve**

Stop and assume an upright position in the water. When in position, open the Manual Dump Valve by gently pulling downward on the Oral Valve/Power Inflation Valve Assembly (fig. 7 - A). It is not necessary to use excessive pressure to pull on the hose assembly. Valve travel is limited and pulling harder will not increase the air flow. To close the Manual Dump Valve, stop pulling downward, and release.

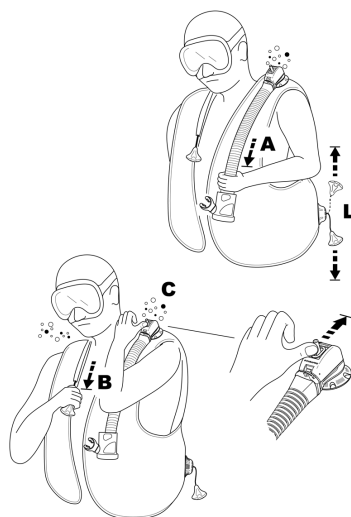

fig. 7

**WARNING**

**Keep sand and other contamination out of the Oral Valve mouthpiece and valve button. Under certain conditions, contamination can cause the valve to not close completely. If this occurs while diving, shake the valve while depressing it several times. If the valve leaks or remains inoperable, terminate the dive. Diving with a leaking Buoyancy Compensator or with valves that do not operate properly may result in a loss of buoyancy control that could result in injury or death.**

**Deflating the BC with the Oral Valve (BPI and /or AIR 2)**

Assume a head up position in the water. Raise the Oral Valve above and in front of your face. (This insures the Oral valve will be positioned above the air bubble in the BC.). Depress the Oral Valve button and visually confirm that air is escaping from the mouthpiece. For best control, let air out in a series of short, measured amounts while observing the effects on your buoyancy.

## WARNING

- The SCUBAPRO® Dual Manual Dump Valve (Patent) has a safety hand pin on the top (fig. 7 - C) that, by pushing it upward, releases air in case of failure of the Manual Dump System (broken cable, pin, etc.) or while breathing from an Air 2.
- With all deflation methods, hold the valve open no longer than needed. This helps prevent excess water from entering the BC.
- Do not depress the Oral Valve button when activating the Manual Dump valve, as water may enter the BC through the Oral Valve mouthpiece.

### **Over Pressure Valve Operation**

The Over Pressure Valve prevents over-inflation of the BC. If the internal pressure exceeds the spring pressure in the Over Pressure Valve, the valve automatically opens and releases air to prevent damage to the BC. The valve will automatically close when the internal pressure goes below the spring pressure in the Over pressure Valve.

### **Shoulder Valves**

SCUBAPRO Buoyancy Compensators have over pressure valves on either one or both shoulders that act also as dump valves. The dump valve on the left shoulder is always present and is activated either by:

- a) pulling gently on the hose assembly (fig. 7 - A).
- b) pushing on the rod that protrudes out of the valve casing (fig. 7 - C) (Patented):  
this system could be useful also to purge air of another diver having problems (panic, beginner diver, unconsciousness, etc.).

The valve on the right shoulder, if present, is activated by pulling gently on the knob which is connected via a lanyard to the valve itself (fig. 7 - B). To operate either style of dump valve, orient the valve to a position higher than the air bubble in the BC. Activate the dump valve until the desired amount of buoyancy is reached. Stop pulling/pushing to close the valve (fig. 7 - B).

### **Lower Dump Valve (fig. 7 - L)**

An over Pressure Valve located at the lower rear of the BC is equipped with lanyard and pull knob. This lower Dump Valve can be manually activated when the Diver operates them in a horizontal or head down orientation in the water, positioning them at the highest point of the air bubble.

## **10. BC HARNESS ADJUSTMENT - GENERAL FEATURES**

### WARNING

**Adjust the BC so that it does not restrict your breathing when fully inflated. Restriction of normal breathing while wearing your BC could result in injury or death. Before each use, check all bands, straps, quick-connect clips, and/or cummerbund for proper adjustment to the user.**

### **Opening and securing the belts**

In order to quickly open or close the jacket, quick-lock and -release buckles are used on both the shoulders and the cummerbund.

The cummerbund also features a Velcro closure system.

### **Adjustable shoulder (some models: see model features)**

Shoulder straps are adjustable on your BC. These straps adjust by a length of webbing passing through a locking feature on a quick release buckle. Tighten buckles by grasping

the free end of the adjustment webbing and pulling firmly downward. Lift the front of the buckle upwards while wearing the BC to loosen.

A quick release feature may also be incorporated into the buckle. Check for two tabs on either side of the buckle that may be squeezed to separate the buckle halves.

Front and shoulder closures on the BC are used to keep it in a low drag configuration.

## 11. BC EXAMINATION AND PROCEDURES

Pre-dive, dive and post-dive BC examination helps to identify equipment problems before unsafe conditions exist, preventing diving accidents. All equipment must be regularly inspected by an authorized SCUBA equipment repair facility.



### WARNING

**DO NOT DIVE with a BC that does not pass any of the Pre-Dive, Dive or Post-Dive inspection points and tests. Loss of buoyancy control or air holding integrity could occur, resulting in serious injury or death.**

#### *Pre-Dive Visual Inspection and Valve Test:*

1. **Examine** the entire BC for cuts, punctures, frayed seams, excessive abrasion, loose/missing hardware and other damage of any kind.
2. **Inspect** the Oral Valve, Power Inflation Valve, Manual Dump Valve and Over Pressure Valve(s) for cracks, damage, or contamination.
3. **Operate** the Power Inflation Valve (with the LP hose attached and charged with air pressure), Oral Valve, manual Dump Valve and Over Pressure Valve, checking for proper operation and resealing. If the OP Valve has a Pull Dump, test it by pulling on the cord.
4. **Inflate** the BC through the Oral Valve until it is firm. Listen and check for leaks. Let the BC stand inflated for 30 minutes or more, then check the BC for loss of air.
5. **Soak** the cylinder band(s) and fit the BC to a SCUBA cylinder, pull up on the BC while attached on the SCUBA cylinder, checking that the BC will not slip while diving.
6. While wearing the BC, **adjust** the straps and other attachments on the BC for a comfortable fit that does not restrict breathing. Make these adjustments with the BC inflated and while wearing the exposure suit you intend to dive with.
7. **Check** quick release weight pockets or systems that retain weight (if your BC is equipped with them). Make sure that their retention systems are fully engaged and attached : they have to be released, and the weight removed from your equipment, quickly.
8. **Cross check** all valves' operation and visually inspect your BC with your dive partner before each dive, prior to entering the water.



### WARNING

**DO NOT DIVE with a BC that is damaged, leaks air, or does not function properly. Terminate any dive as safely and quickly as possible if the BC becomes damaged, leaks air, or does not function properly.**

#### *Post-Dive : BC Cleaning and examination and Storage*

With proper care and service, your BC should provide years of enjoyment. Maintenance and care procedures must be observed and are as follows:

1. **Rinse the BC** thoroughly inside and out with fresh water after every use (do not use any aggressive solvent and/or cleansing liquid).

- Fill the BC Inner Bladder, approximately 1/4 full with clean fresh water through the Oral valve.
  - Orally inflate the BC and shake to distribute water inside of the BC.
  - Hold the BC upside down, depress the Oral Valve Button, and allow all water and air to drain from the Oral Valve mouthpiece.
  - Repeat one or two more times.
  - Rinse the entire BC with fresh water by dipping in a tub or spraying with a hose.
  - Rinse all valves to make sure all sand and other debris is removed.
2. **Dry the BC:** if hanging, make sure it is not in direct sunlight. Dry completely if storing, slightly inflated.



## WARNING

**Avoid prolonged or repeated exposure to chlorinated water, such as in swimming pools. Wash your BC immediately after any use in chlorinated water. Chlorinated water can oxidize fabrics and materials on your BC, thereby shortening their life, and cause colors (especially neon) to fade. Damage and fading from prolonged exposure to chlorinated water is specifically not covered under warranty.**

## 12. STORAGE

Store your BC, after it has fully dried, by partially inflating and then placing it in a cool, dark, dry, location: ultraviolet rays will shorten the life of the fabric and cause colors to fade. Slightly grease (with SCUBAPRO Lubricant Grease), the AIR 2 and BPI couplings.

### **Inspection and Service Interval**

Your BC should be inspected and maintained at an Authorized Service Center at least once a year, more often if you dive frequently. Any damage caused due to failure to properly maintain the BC is not covered by the warranty.

## 13. GENERAL SPECIFICATIONS

### **Shelf life**

Shelf life is seven years for a new, unused BC when deflated and stored in a sealed container or bag at typical room temperature, with no exposure to UV.

### **Operating temperature range**

Air	-20°C	to	+50°C	-4°F	to	122°F
Water	-2°C	to	+40°C	28°F	to	104°F



## WARNING

**Special Instruction in cold water diving methods, and the specific use of this product in cold water, is required prior to cold water diving (temperatures below 10°C/50° F). This instruction is beyond the scope of this manual.**

### **Inspection and Service Interval**

LP hose and Pneumatic Inflation Valve operating pressure	95 – 200 psi (6.5 – 13.8 bar)
Low Pressure Hose Fitting threads	3/8 – 24 UNF
O-Rings - Seals	EPDM – Buna/Nitrile - Silicone

**⚠ WARNING**

This product is designed to use air or nitrogen/oxygen mixtures containing up to 40% oxygen. Use of gas mixtures with increased oxygen, or the addition of helium or other substances, may cause corrosion, deterioration, premature aging or component failure of metal and rubber parts. These actions may result in loss of buoyancy control or air holding integrity of the BC, resulting in injury or death. Non-standard gas mixtures may also present a risk of fire or explosion. Use only nitrogen/oxygen mixtures containing up to 40% oxygen.

**14. T-BLACK**

This is an adjustable single-bag BC made of highly-resistant material (Cordura®), covered in polyurethane, radio frequency welded, with expandable front and rear lift.

The ample pockets, also made of Cordura®, provide excellent resistance against wear and are decorated with raised rubber finishing and a metallic patch insert.

The principal characteristics of this BC are:

- Lifting capacity. The new bag has the back position semiexpandable to get more lifting capacity, and retractable, by means of elastic straps (Airflex Technology System) and, being positioned between bottle and back of the diver, in normal use, it does not create any extra drag.
- An extra right pocket houses the safety buoy or other accessories.
- Integrated weight system.
- Rear pockets for integrated counterweights.

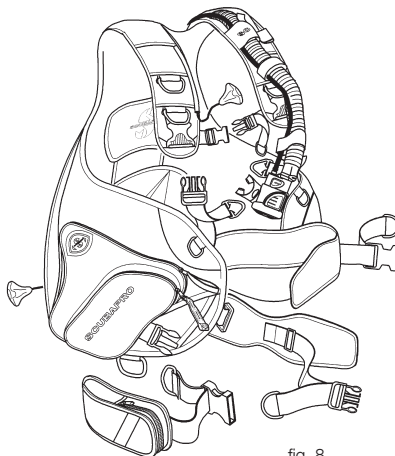

fig. 8

The shoulder pads are covered with a special anti-slip material to improve comfort, and shaped metal D-rings have also been applied. Their angular shape and their size make it easy to hook on accessories, especially heavy ones.

The straps are also covered with anti-slip material, and in the front section they house additional small sundries pockets.

The removable pockets accept up to 11 lb (5 Kg) Ecoweight above the size “M” and up to 5.5 lb (2.5 Kg) in the “S” and “XS” sizes (see assy procedure, fig. 4-1, 4-2).

Each back pocket can be loaded with up to 5.5 lb. (2.5 Kg) SCUBAPRO Ecoweight.

Performance is listed below and printed in the interior patch stitched on the BC.

Sizes	Max Lifting Buoyancy (N*)	Max Lifting Buoyancy (lb)	Max size of bottle (l)
XS	130	29.2	15
S	180	40.5	18
M	220	49.5	
L	230	51.7	
XL	270	60.7	

\*N=Newton

## 15. T-FORCE

This is a classic-cut adjustable single-bag BC, made of highly-resistant material (Cordura®), covered in polyurethane, and radio frequency soldered.

The ample pockets, also Cordura®, provide excellent resistance against wear and are adorned with raised rubber finishing and a metallic patch insert.

The other features are: the integrated weight system and two back extrapockets to hold counterweights.

In addition, it features shoulder pads covered with anti-slip material for optimal comfort; shaped metal D-rings have also been applied on the pads. Their angular shape and their size make it easy to hook on accessories, especially heavy ones.

The straps are also covered with anti-slip material, and in the front section they house additional small sundries pockets.

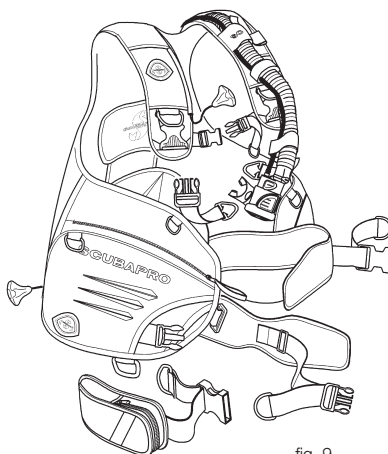

fig. 9

The removable pockets accept up to 11 lb (5 Kg) Ecoweight above the size “M” and up to 5.5 lb (2.5 Kg) in the “S” and “XS” sizes (see assy procedure, fig. 4-1, 4-2).

Each back pocket can be loaded with up to 5.5 lb. (2.5 Kg) SCUBAPRO Ecoweight.

Performance is listed below and printed in the interior patch stitched on the BC.

Sizes	Max Lifting Buoyancy (N*)	Max Lifting Buoyancy (lb)	Max size of bottle (l)
XS	110	24.7	15
S	140	31.5	
M	170	38.2	18
L	180	40.5	
XL	210	47.2	
XXL	230	51.7	

\*N=Newton

### 16. T-SPORT PLUS

The T-SPORT PLUS is equipped with a system featuring integrated front weight pockets, making it stand out as the most convenient BC-vest equipped with this system in the entire T-line.

This is a light-structure, classic-cut, adjustable single-bag BC, made of highly-resistant material (Cordura®), covered in polyurethane, and radio frequency soldered.

It offers the option to attach rotating buckles to the shoulder pads, which make the BC easier to put on and help it fit the body better; it's also ideal for wear by women.

It features ample pockets with graphic finishes achieved using a sublimation printing technology that helps the color to better resist exposure to the sun.

The backpack is covered with a special anti-slip material to maximize comfort.

The right shoulder pad also features a nylon D-ring.

The removable pockets accept up to 11 lb (5 Kg) Ecoweight above the size "M" and up to 5.5 lb (2.5 Kg) in the "S" and "XS" sizes (see assy procedure, fig. 4-1, 4-2).

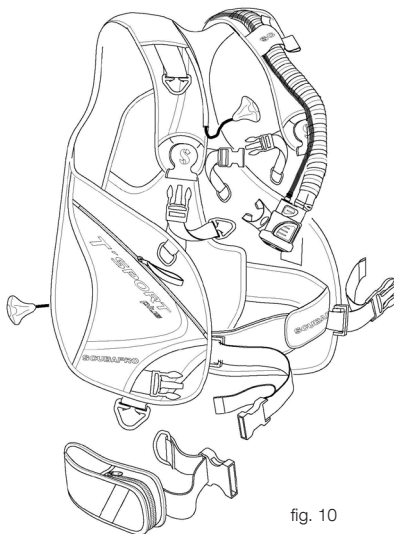

fig. 10

Performance is listed below and printed in the interior patch stitched on the BC.

Sizes	Max Lifting Buoyancy (N*)	Max Lifting Buoyancy (lb)	Max size of bottle (l)
XS	110	24.7	15
S	140	31.5	
M	170	38.2	18
L	180	40.5	
XL	210	47.2	
XXL	230	51.7	

\*N=Newton

## 17. T-ONE

This is the simplest adjustable single-bag BC in the line.

Fundamental but reliable, it is ideal for intensive use, such as for dive centers.

The single-bag is made of highly-resistant material (Cordura®), covered in polyurethane, and radio frequency welded.

It provides ample pockets with Velcro.

It also has a backpack covered in a special anti-slip material to maximize comfort.

The T-One has a color coordination pad, to easily identify the size.

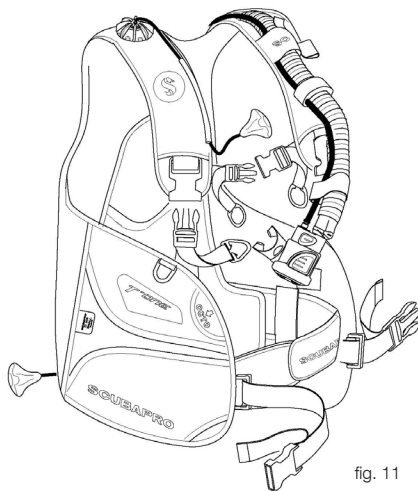

fig. 11

Performance is listed below and printed in the interior patch stitched on the BC.

Sizes	Max Lifting Buoyancy (N*)	Max Lifting Buoyancy (lb)	Max size of bottle (l)	Color Coord.
XXS	90	20.2	15	purple
XS	110	24.7		bronze
S	140	31.5		neon green
M	170	38.2	18	blue
L	180	40.5		neon yellow
XL	210	47.2		neon orange
XXL	230	51.7		dark grey

\*N=Newton

## 18. X-FORCE

X-Force by SCUBAPRO is the ultimate evolution of a classic-cut adjustable single-air cell BC. The new X-Force model provides extra ergonomic fit and added comfort, due to an innovative design which reduces both pressure and weight distribution on the back. X-Force is made of high-resistant material (Cordura® 1000) covered in polyurethane and radio frequency soldered.

The improved integrated weight system is light, simple and comfortable due to the new buckle retaining system. One hand is all that's needed to attach and release the Ecoweight pockets. Additional back pockets allow for convenient trim counterweight storage.

The new aircell design provides increased buoyancy and has added extra volume in the lower back.

Pockets are large and made from strong Cordura® material. The dynamic shape of the pockets is highlighted by the attractive contrasting color design of the BC. Classic SCUBAPRO logo on one side and the new X-Force logo on the other.

New air-net material around the neck and on the upper sides gives a soft touch and comfortable feel in critical areas.

New ergonomic backpack is light and soft with air-net inserts.

In addition, X Force features shoulder pads and straps covered with anti-slip material for optimal comfort and added safety; shaped metal D-rings have also been applied on the pads. Their angular shape and generous size make even heavy accessories easy to attach and access.

Side grommets are standard for SCUBAPRO knife attachment.

The removable pockets hold up to 11 lb (5 Kg) of Ecoweight for sizes Medium and above and 5.5 lb (2.5 Kg) for sizes Small and X-Small.

Each back trim-weight pocket can be loaded with up to 5.5 lb. (2.5 Kg) of SCUBAPRO Ecoweight.

Performance is listed below and printed in the interior patch stitched on the BC.

Sizes	Max Lifting Buoyancy (N*)	Max Lifting Buoyancy (lb)	Max size of bottle (l)
XS	110	24.7	15
S	140	31.5	
M	180	40.5	
L	200	44.9	18
XL	220	49.5	
XXL	240	54.0	

\*N=Newton

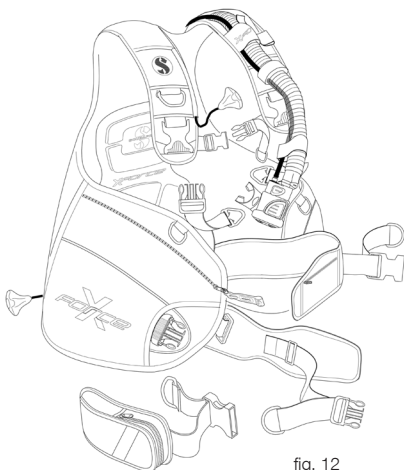

fig. 12

## 19. GEO

If you like to travel to your dive locations, our new SCUBAPRO Geo travel BC is ready to go with you.

Geo is the ultimate answer to your dive travelling needs: light, foldable and reliable yet incorporating SCUBAPRO quality.

Its modern and unique style matches the spirit of adventure matched with innovative technical solutions. This is an adjustable single-air cell BC with a new ergonomic cut that provides more than just lightweight comfort. Geo is made of light and resistant material (Nylon 210 denier) covered in polyurethane and radio frequency soldered for maximum wear.

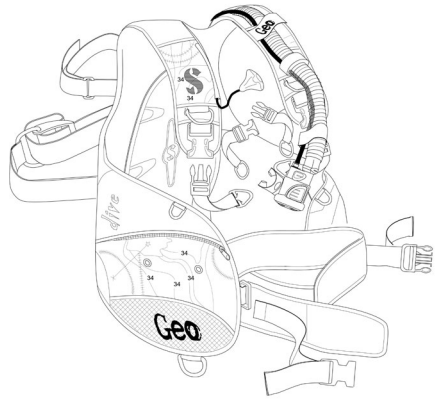

fig. 13

The newly designed aircell provides high buoyancy without affecting comfort. High profile pockets allow easy accessibility in any conditions. Pockets are large and strong, made of printed nylon fabric reinforced by a strong mesh material which also allows quick water release.

New air-net ergonomic backpack is lightweight and soft. With no rigid elements, this backpack can be easily folded and stored in your travel bag. The exclusive GO/DIVE buckle keeps this BC exceptionally well stored and folded. Once the buckle is released, the BC easily unfolded and you are ready to dive.

The tank attachment is provided by the classic main belt with a plastic buckle plus an additional upper belt. It gives the tank an astonishingly good balance in any position and doesn't put any added pressure on your back.

Geo is incredibly lightweight (1.9kg L size) and doesn't take much room in your bag once folded up and attached for allow easy storage. Geo comes in a small lightweight dedicated 'travel' bag for added protection. It couldn't be easier to pack in your travel baggage.

Lightweight Aluminum D-rings have also been applied on the pads. Their angular shape and generous size make even heavy accessories easy to attach and access

Side grommets are provided for SCUBAPRO knife attachment.

Performance is listed below and printed in the interior patch stitched on the BC.

Sizes	Max Lifting Buoyancy (N*)	Max Lifting Buoyancy (lb)	Max size of bottle (l)
XS	100	22.5	15
S	120	27.0	
M	140	31.5	
L	160	36.0	18
XL	190	42.7	

\*N=Newton

## 20. MASTER JACKET

**(certified as CBRD-EN 12628, that includes also the EN 1809 norms, that means it can be used as buoyancy compensator underwater as well as Life Jacket on the boat)**

The original design of this legendary model was developed in 1978: it was the first diving Jacket ever produced and its design and technology is so successful that as of today, it is practically unchanged from the original.

The Master Jacket is quite different from all other models on the market due to its “three dimensional balance” buoyancy control, regardless of the sequence of movements or in what position the movement begins underwater, the internal air bubble cannot cause rotational movements, which would destabilize the diver (fig. 12 - A).

This outcome is owed to the peculiar internal bag design, that uses three interconnecting circles or passageways, permitting the air bubble an unobstructed circulation (fig. 12 -A1). If the ring is interrupted (fig. 12 - B), a rotation of the ring 90 itself, which would bring one of the ends (E or E1) to the highest point (where the bubble (O) resides), would cause the rotation to stop. If the ring is not interrupted, however, the rotation can continue until it reaches the most stable configuration.

This guarantees not only an unparalleled level of comfort during diving, but also a “face-up” position of the diver on the surface, even in case of unconsciousness, providing thus an inherent level of safety. For this main reason, the Master Jacket has been tested and certified as the unique worldwide CBRD (Combined Buoyancy Rescue Device): meaning that the Jacket can be used as a buoyancy compensator underwater as well as a Life Jacket on the boat!

Other skilful technical solutions and quality materials support the basic safety concept: the Master Jacket consists of two bags: an internal bag that holds the air bubble, made of polyurethane/polyether, radio frequency welded, and an external bag made of tough polyester fabric, sewn with thick polyester thread, that guarantees mechanical and abrasion resistance.

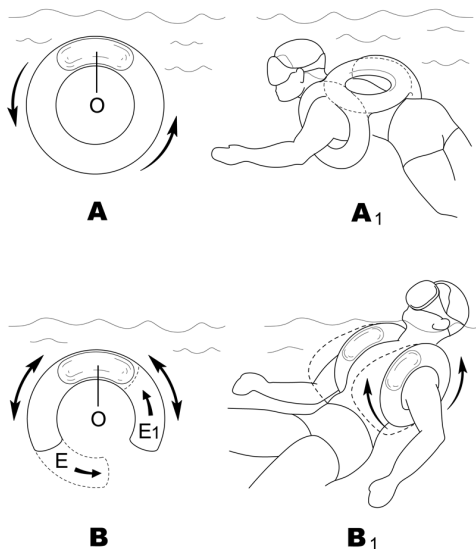

fig. 12

The webbing system is conceived for the maximum safety too: in fact there are adjustable shoulder belts with 50 mm. (2") metal buckles, easy to adjust even with thick gloves, to hold tight the diver, even jumping into the water from many meters ! The chest straps are elastic to prevent squeezing of the lungs, if the bag is over inflated. Fotoluminescent patches complete the safety features.

In the right epaulette there is an elastic loop (fig. 13 - L), to hold a blinking light during the night dive (such as SCUBAPRO Safety Light or Strobe Light).

Back pack, back plate, soft padding cummerbund and Supercinch Q.A. are described in the Manual.

All valves, inflator and tank band assy, are described in the manual.

In addition, the Master Jacket has the possibility to apply a Pony Bottle System and/ or CO2 detonator ( both of them are optional) that fit on special pockets (fig. 13 PB / CO<sub>2</sub>) so that they do not hang out.

Heavy duty AISI 316 stainless steel "D" rings allow to hook up heavy accessories.

Performances (printed in the patches stitched besides the back pack) are listed below:

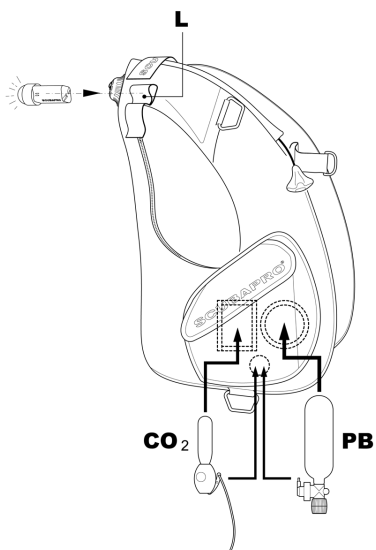

fig. 13

Performance is listed below and printed in the interior patch stitched on the BC.

Sizes	Max Lifting Buoyancy (N*)	Max Lifting Buoyancy (lb)	Max size of bottle (l)	
S	200	44.9	10+10	
M	220	49.5		
L	230	51.7		
XL	250	56.2		
XXL	250	56.2		

\*N=Newton

## 21. KNIGHTHAWK LADYHAWK SEAHAWK LITEHAWK

These are back floatation BCs which consist of a single bag WING, an independent harness and an adjustable cummerbund system (see fig. 14).

The system is modular, making it possible to apply the optional weight pockets both on the back and on the cummerbund, by using the integrated weight system pockets.

Our Hawk jackets leave the diver's chest and arms free, so it is ideal for any kind of underwater work and offers more freedom of movement.

In addition, when the bag is empty or slightly inflated, there is less drag because it is kept slim and maintains a low profile by the elastic bands.

LADYHAWK was specially designed to fit the female body.

SEAHAWK is a KNIGHTHAWK special version provided with pockets and an unisex shoulder design.

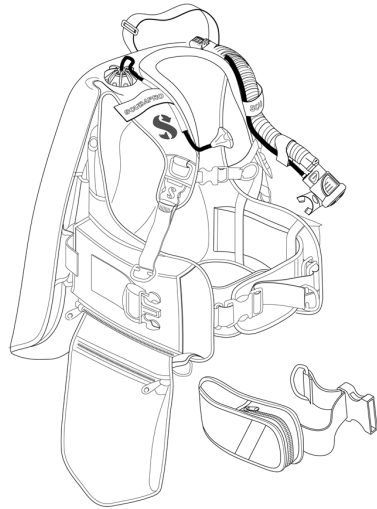

fig. 14

LITEHAWK is the lightest version possible being just a light harness with a bladder.

The principal characteristics of these models are:

- Holding system for the rear bag with additional elastic bands that make it possible to keep it basically covered by the diver's own shape when deflated, reducing hydrodynamic drag to the lowest conceivable levels.
- The elastic system on the cummerbund allows for perfect adherence and fit at all depths and under any conditions.
- Soft edges on the neck improve diver comfort.
- Rear pockets with integrated counterweights.
- Integrated weight system.
- A single adjustment for the straps makes it even easier to put the BC on quickly and correctly, decreasing the number of dangling straps and making it easier to wear.

The bag is made of Nylon 420 and Cordura® 1000 coated with polyurethane and the harness is made of a polyester fabric with soft inner padding.

The removable pockets can contain up to 12 lb (5.5 Kg) of Ecoweight above size "M" for KNIGHTHAWK and all sizes for SEAHAWK and up to 10 lb (4.5 Kg) in the "S" size for KNIGHTHAWK and all sizes for LADYHAWK.

Each back pocket of KNIGHTHAWK, LADYHAWK and SEAHAWK can be loaded with up to 5 lb. (2.25 Kg) of SCUBAPRO Ecoweight.

All valves and tank band assembly are described in the Manual. Performance (printed in the patches stitched besides the back pack) are listed below:

**LADYHAWK:**

Performance is listed below and printed in the interior patch stitched on the BC.

Sizes	Max Lifting Buoyancy (N*)	Max Lifting Buoyancy (lb)	Max size of bottle (l)	
S	150	33.7	18	
M	150	33.7		
M/L	150	33.7		
L	150	33.7		

\*N=Newton

**KNIGHTHAWK:**

Performance is listed below and printed in the interior patch stitched on the BC.

Sizes	Max Lifting Buoyancy (N*)	Max Lifting Buoyancy (lb)	Max size of bottle (l)	
S	150	33.7	18	
M	200	44.9		
L	200	44.9		
XL	200	44.9		
XXL	200	44.9		

\*N=Newton

**SEAHAWK:**

Performance is listed below and printed in the interior patch stitched on the BC.

Sizes	Max Lifting Buoyancy (N*)	Max Lifting Buoyancy (lb)	Max size of bottle (l)	
XS	250	56.2	18	
S	250	56.2		
M	250	56.2		
L	250	56.2		
XL	250	56.2		
XXL	250	56.2		

\*N=Newton

**LITEHAWK:**

Performance is listed below and printed in the interior patch stitched on the BC.

Sizes	Max Lifting Buoyancy (N*)	Max Lifting Buoyancy (lb)	Max size of bottle (l)	
XS/S	250	56.2	18	
M/L	250	56.2		
L/XL	250	56.2		

\*N=Newton

## 22. CLASSIC UNLIMITED - CLASSIC EXPLORER

The stabilizing jacket was invented by SCUBAPRO. It features the most complete buoyancy control system ever.

Stabilizing jackets utilize unrestricted internal passageways allowing air to flow continuously throughout the jacket accumulating at the highest point. The diver is surrounded by that bubble and moves easily and precisely. At the surface stabilizing jackets provide a very comfortable and relaxed floating position which allows complete safety in a 'face up' position.

These models are the culmination of years of SCUBAPRO experience on BC design and production. The original design of the legendary model has been developed since 1978: it was the first diving Jacket ever produced and the results were so good that up until today, it is practically, unchanged. We now have 2 different versions of the stabilizing jacket to meet all diver needs.



fig. 15

The Classic Unlimited is a high end BC targeting demanding divers who desire a BC which is as complete as possible.

Classic Explorer is dedicated to diving centers and to individual divers who prefer a simple yet quality BC, however without.

Compromising on safety and comfort.

### **Both versions feature:**

1. High durability double coated 420-denier nylon fabric.
2. Basic air cell with reinforced heavy polyester fabric and threads.
3. 3 dump valve deflation system enabling the diver to dump air in any underwater position.
4. Standard belt with stainless steel cam buckle allows easy and secure closure of the BCD.
5. Pre-bent stainless steel D-rings allow all accessory attachments.
6. Two large volume pockets equipped with double sliders offer convenient access to accessories and secure storage no matter you are left or right hand.
7. Knife attachment system is situated on both sides.
8. Super cinch tank band is provided as standard.



Back packs, back plate, soft padding and Supercinch Q.A. are the ones described in the Manual.

### **Classic Unlimited also features:**

1. Integrated quick release weight system.
2. Two rear trim pockets which counterbalance front weights and provide a well-balanced swimming position.
3. Soft neoprene neck roll and thermoformed foam-padded back pad provide exceptional dive comfort in and out of the water.
4. Flexible cummerbund with stainless steel cam buckle.

The removable pockets accept up to 12 lb (5.5 Kg) above the size "L" and up to 10 lb (4.5 Kg) in the sizes below (see assembly procedure, fig. 4-1, 4-2), and each back pocket can be loaded up to 5lb (2.25 Kg).

Performance is listed below and printed in the interior patch stitched on the BC.

Sizes	Max Lifting Buoyancy (N*)	Max Lifting Buoyancy (lb)	Max size of bottle (l)	
XS	140	31.5	18	
S	140	31.5		
M	210	47.2		
L	280	62.9	10+10	
XL	310	69.7		

\*N=Newton

## 23. BELLA BC

SCUBAPRO is pleased to present the Bella buoyancy compensator, specifically designed and meticulously tailored for female divers. The new front-adjustable Bella incorporates an exciting array of renowned SCUBAPRO features, including a SCUBAPRO exclusive wraparound air bladder, which retains its cradle-like shape even when fully inflated. Front-adjustable jackets allow variations of fit, regardless of the thickness of suit worn.

Quick-release adjustable shoulder buckles make this style of BC very easy to put on, to take off and easy to use. A variety of styles and sizes offer a custom-like fit.

Bella BC has been specifically designed for female divers featuring contoured hip indents.



fig. 16

Wrap-around air bladder retains a cradle-like shape to “hug” the female ladies diver throughout the full range of inflation, thereby ensuring optimum comfort and total control in all diving environments. Soft material in shoulder area result in substantially enhanced topside comfort when gearing up for dives. Front-adjustable design with rotating quick-release shoulder buckles allows maximum comfort. The 5-point deflation system with 3 dump valves enables you to dump air from a variety of underwater positions. Proprietary quick-release integrated weight system offers more comfort and convenience. Two rear trim pockets counterbalance the front weight and provide a well-balanced swimming position. Soft neoprene neck and padded backpack for optimum comfort. Fully-adjustable cummerbund to ensure proper fit. Zippered cargo pockets complete the finishing detail as convenient accessory D-rings.

The removable pockets accept up to 10 lb (4.5 Kg) (see assembly procedure, fig. 4-1, 4-2), and each back pocket can be loaded up to 5lb (2.25 Kg).

Back packs, back plate, soft padding, cummerbund system and Supercinch Q.A. are the ones described in the Manual (paragr. 1/2).

Performance is listed below and printed in the interior patch stitched on the BC.

Sizes	Max Lifting Buoyancy (N*)	Max Lifting Buoyancy (lb)	Max size of bottle (l)	
XS	100	22.5	10	
S	130	29.2	15	
M	140	31.5		
L	140	31.5		
XL	160	36.0		

\*N=Newton

## 24. EQUATOR

### Buoyancy Compensator Owner’s Manual Addendum

SCUBAPRO has designed the Equator buoyancy compensator, for demanding travel divers.

The front-adjustable Equator incorporates an exciting array of renowned SCUBAPRO features. Front-adjustable jackets allow variations of fit, regardless of the thickness of suit worn. Quick-release adjustable shoulder buckles make this style of BC very easy to put on, to take off and easy to use. A variety of styles and sizes offer a custom-like fit. Equator BC has been specifically designed for demanding travel divers focused on light weight equipment: Front-adjustable design with rotating quick release shoulder buckles allows maximum comfort. The 5- point deflation system with 3 dump valves enables you to dump air from a variety of underwater positions.



fig. 17

Proprietary quick-release integrated weight system offers more comfort and convenience. Soft neoprene neck and padded backpack for optimum comfort. Fully-adjustable cummerbund to ensure proper fit. Zippered cargo pockets complete the finishing detail as convenient accessory D-rings.

The removable pockets accept up to 10 lb (4.5 Kg) (see assy procedure, fig. 4-1, 4-2).

Back packs, back plate, soft padding, cummerbund system and Supercinch Q.A. are the ones described in the Manual.

Performance is listed below and printed in the interior patch stitched on the BC.

Sizes	Max Lifting Buoyancy (N*)	Max Lifting Buoyancy (lb)	Max size of bottle (l)	
XS	100	22.5	10	
S	120	27.0	15	
M	130	29.2		
L	150	33.7		
XL	170	38.2		

\*N=Newton

## **SUBSIDIARIES**

**SCUBAPRO UWATEC  
ASIA PACIFIC**

1208 Block A, MP Industrial Center  
18 Ka Yip St.  
Chai Wan - Hong Kong

**SCUBAPRO UWATEC  
GERMANY**

Johann-Höllfritsch-Str.47  
90530 Wendelstein - Germany

**SCUBAPRO UWATEC  
SWITZERLAND**

Oberwilerstrasse 16  
CH-8444 Henggart - Switzerland

**SCUBAPRO UWATEC  
AUSTRALIA**

Unit 21 380 Eastern Valley Way  
Chatswood NSW 2067 - Australia

**SCUBAPRO UWATEC  
ITALY**

Via Tangoni, 16  
16030 Casarza Ligure (GE) - Italy

**SCUBAPRO UWATEC  
U.K.**

Vickers Business Centre  
Priestley Road,  
Basingstoke, Hampshire RG24 9NP  
England

**SCUBAPRO UWATEC  
BENELUX**

Ave des Arts  
10-11 Bte 13  
1210 Brussels - Belgium

**SCUBAPRO UWATEC  
ASIA LTD**

Mitsubishi Juko Yokohama Bldg.  
3-3-1 Minatomirai, Nishi-ku  
Yokohama 220-0012 - Japan

**SCUBAPRO UWATEC  
USA & LATIN AMERICA**

1166 Fesler Street  
El Cajon, CA 92020

**SCUBAPRO UWATEC  
FRANCE**

Nova Antipolis Les Terriers Nord  
175 Allée Belle Vue  
06600 Antibes - France

**SCUBAPRO UWATEC  
SPAIN**

Pere IV, 359, 2º  
08020 Barcelona - Spain



Johnson Outdoors Diving