



apeks
TECHNICAL SUPPORT

EGRESS SECOND STAGE REGULATOR



MAINTENANCE MANUAL FOR AUTHORISED TECHNICIANS

Document No. AP5832

Issue 1
3/10/2003

APEKS MARINE EQUIPMENT LTD, NEPTUNE WAY, BLACKBURN, LANCASHIRE. BB1 2BT
Tel: 0044 (0) 1254 692200 Fax: 0044 (0) 1254 692211 E-mail: info@apeks.co.uk Web: www.apeks.co.uk

Contents

COPYRIGHT NOTICE.....	3
INTRODUCTION	3
WARNINGS, CAUTIONS & NOTES	3
SCHEDULED SERVICE.....	3
GENERAL GUIDELINES.....	3
GENERAL CONVENTIONS.....	4
DISASSEMBLY PROCEDURES.....	4
REASSEMBLY PROCEDURES.....	7
FINAL TESTING.....	10
TABLE 1 - TROUBLESHOOTING GUIDE.....	11
TABLE 2 - RECOMMENDED TOOL LIST	12
TABLE 3 - RECOMMENDED LUBRICANTS AND CLEANERS.....	13
CLEANING AND LUBRICATION PROCEDURE.....	14
TABLE 4 -TORQUE SPECIFICATIONS.....	15
TABLE 5 - TEST BENCH SPECIFICATIONS	15
EXPLODED PARTS DRAWING.....	16

COPYRIGHT NOTICE

This manual is copyrighted, all rights reserved. It may not, in whole or in part, be copied, photocopied, reproduced, translated, or reduced to any electronic medium or machine readable form without prior consent in writing from Apeks Marine Equipment Ltd. It may not be distributed through the internet or computer bulletin board systems without prior consent in from Apeks Marine Equipment Ltd.

©2004 Apeks Marine Equipment Ltd.

Egress Maintenance Manual

(AP5832 Issue 1)

INTRODUCTION

This manual provides factory prescribed procedures for the correct maintenance and repair of the Apeks Egress. It is not intended to be used as an instructional manual for untrained personnel. The procedures outlined within this manual are to be performed only by personnel who have received factory authorized training through an Apeks Service & Repair Seminar. If you do not completely understand all of the procedures outlined in this manual, contact Apeks to speak directly with a Technical Advisor before proceeding any further.

WARNINGS, CAUTIONS & NOTES

Pay special attention to information provided in warnings, cautions, and notes that are accompanied by one of these symbols:



WARNINGS indicate a procedure or situation that may result in serious injury or death if instructions are not followed correctly.



CAUTIONS indicate any situation or technique that will result in potential damage to the product, or render the product unsafe if instructions are not followed correctly.



NOTES are used to emphasise important points, tips, and reminders.

SCHEDULED SERVICE

It is recommended that the Apeks Egress second stage regulator should be serviced annually regardless of usage.

However, If at all unsure about the correct functioning of the Apeks Egress, then it must be officially inspected immediately.

All service and inspection details need to be documented in the *Regulator Service Record* in the back of the Owner's Manual to keep the *Limited Lifetime Warranty* in effect.

An Official Inspection consists of:

1. A pressurised immersion test of the entire unit to check for air leakage.
2. Checking for stable medium pressure that is within the acceptable range.
3. Checking for opening effort that is within the acceptable range.
4. Checking for smooth operation of the control knob and venturi switch (if fitted.)
5. A visual inspection of any filters for debris or discoloration.
6. A visual inspection of the exhaust valve(s) to see that they are in good condition and that it is seating against a clean and undamaged surface.
7. A visual inspection of the mouthpiece looking for tears or holes and checking the general condition.
8. Pulling back hose protectors and checking that the hoses are secure in the hose crimps.

If a regulator fails steps 1,2,3 or 4 the entire regulator should be serviced. If a regulator fails 5,6 or 7 it will be up to the technician's discretion whether or not a full service is required. Failure of step 8 requires replacement of the hose.

GENERAL GUIDELINES

1. In order to correctly perform the procedures outlined in this manual, it is important to follow each step exactly in the order given. Read over the entire manual to become familiar with all procedures and to learn which specialty tools and replacement parts will be required before commencing disassembly. Keep the manual open beside you for reference while performing each procedure. Do not rely on memory.
2. All service and repair should be carried out in a work area specifically set up and equipped for the task. Adequate lighting, cleanliness, and easy access to all required tools are essential for an efficient repair facility.
3. During disassembly, reusable components should be segregated and not allowed to intermix with nonreusable parts or parts from other units. Delicate parts, including inlet fittings and valve seats which contain critical sealing surfaces, must be protected and isolated from other parts to prevent damage during the cleaning procedure.
4. Use only genuine Apeks parts provided in the 2nd stage service kit (AP0219). DO NOT attempt to substitute an Apeks part with another manufacturer's, regardless of any similarity in shape or size.
5. Do not attempt to reuse mandatory replacement parts under any circumstances, regardless of the amount of use the product has received since it was manufactured or last serviced.
6. When reassembling, it is important to follow every torque specification prescribed in this manual, using a calibrated torque wrench. Most parts are made of either marine brass or plastic, and can be permanently damaged by undue stress.

GENERAL CONVENTIONS

Unless otherwise instructed, the following terminology and techniques are assumed:

1. When instructed to *remove, unscrew, or loosen* a threaded part, turn the part anti-clockwise.
2. When instructed to *install, screw in, or tighten* a threaded part, turn the part clockwise.
3. When instructed to remove an 'O' Ring, use the pinch method (see figure below) if possible, or use a brass, aluminium or plastic 'O' Ring removal tool. Avoid using hardened steel picks, as they may damage 'O' Ring sealing surfaces. All 'O' Rings that are removed are discarded and replaced with brand new 'O' Rings.

Pinch Method

Press upwards on sides of 'O' Ring to create a protrusion.

Grab 'O' Ring or insert 'O' Ring tool at protrusion.

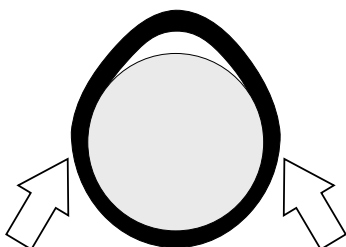

4. The following acronyms are used throughout the manual: MP is Medium Pressure; HP is High Pressure; PN is Part Number.
5. Numbers in parentheses reference the key numbers on the exploded parts schematics. For example, in the statement, "...remove 'O' ring (4) from...", the number 4 is the key number to the Spring Carrier 'O' Ring.

DISASSEMBLY PROCEDURES

 **NOTE:** Before performing any disassembly, refer to the exploded parts drawing, which references all mandatory replacement parts. These parts should be replaced with new, and must not be reused under any circumstances - regardless of the age of the regulator or how much use it has received since it was last serviced.

 **CAUTION:** Use only a plastic, brass or aluminium 'O' Ring removal tool (PN AT54) when removing 'O' Rings to prevent damage to the sealing surface. Even a small scratch across an 'O' Ring sealing surface could result in leakage. Once an 'O' Ring sealing surface has been damaged, the part must be replaced with new. **DO NOT** use a dental pick, or any other steel instrument.

Removal of hose

1. Whilst holding the Inlet Fitting (12) stationary with a 19mm spanner turn the hose swivel anti-clockwise using an $1\frac{1}{16}$ " spanner. Taking care not to scratch the 'O' Ring grooves, remove the 'O' Rings from both the inside of the hose swivel and from the male end of the hose.

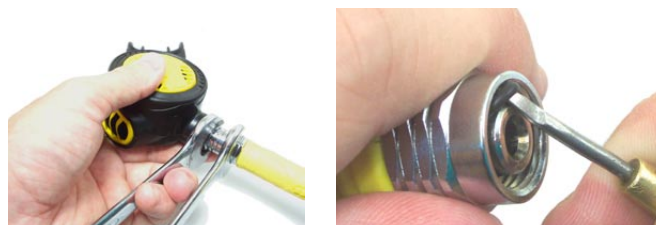

2. Pull back the two hose protectors and inspect the hose crimps. If either crimp is damaged or the hose is pulling out of the crimp then the hose must be replaced.



Removal of diaphragm

3. Using the Egress Locking Ring Tool (AT62) unscrew the front locking ring (19) and remove the front cover (18).

 **NOTE:** Ensure that tool is aligned with both locking ring and front cover before unscrewing.



4. Using the reverse side of the Egress Locking Ring Tool (AT62), fully unscrew the inner locking ring (17).



5. Carefully lift out Friction Ring (16) and Diaphragm (15).



Removal of valve assembly

6. Using a 19mm ring spanner, unscrew the Inlet Fitting (12).



7. Using a 5mm Allen Key and **by screwing clockwise** remove the Valve Seat (9) from the Inlet Fitting (12).



8. Remove the 'O' Rings (10 & 11) from the both the Valve Seat and the Inlet Fitting.



9. Withdraw and lift the Spindle Assembly (2-8) out of the Case (1).



10. Whilst gently pushing the Shuttle Valve (6) into the Spindle Body (2), remove the Lever (8) by sliding out the lever feet one at a time.



11. Carefully remove the Shuttle Valve Assembly (3-7) from the Spindle Body (2) and separate the Spring Carrier (3), the Valve Spring (5) and the Shuttle Valve (6).



- Remove the 'O' Ring (4) from the Spring Carrier (3) and, using a fingernail, remove the Rubber Seating (7) from the end of the Shuttle Valve (6).

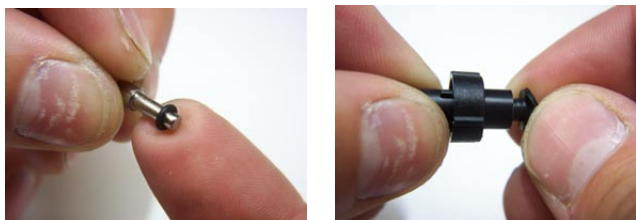

Inspection and Removal of Exhaust Valves

 **NOTE:** *It is not always necessary to remove the Exhaust Gate and the Exhaust Valves. A visual inspection of the Valves can be made from inside the case. If the regulator has been leaking or the Exhaust Gate is damaged then the components should be removed.*

- To remove the Exhaust Gate (14) insert a 3mm screwdriver into the holes on the bottom of the Exhaust Gate and carefully push out the tabs in turn. Then simply lift the top edge of the Exhaust Gate out the Case.

 **CAUTION:** **Whilst pushing out tabs, hold a finger close to the head of the screwdriver to prevent damaging the Case.**



- In turn, fold back the edges of each of the Exhaust Valves (13) and inspect underneath. The seating surfaces should be clean and free of damage. Inspect the Exhaust Valves. They should be supple and have well defined edges. If they look undamaged then there is no need to remove them and they may be reused. If there is any sign of deterioration they must be replaced.



 **NOTE:** *If Exhaust Valves (13) are to be removed, pinch edge of Exhaust Valve and pull tail through hole in Case (1)*



Removal of mouthpiece

- Using side cutters, snip the Zip Tie (22). Remove and inspect Mouthpiece (21).



This Ends Disassembly

Before starting reassembly, perform parts cleaning and lubrication according to the procedures outlined in 'Cleaning & Lubrication' on page 14.

REASSEMBLY PROCEDURES

Fitting exhaust valves and exhaust gate

1. If the Exhaust Valves (13) were removed, replace by threading the tails through the retaining holes on the outside of the Case (1) until the barb engages on the inside. If valves are new, cut off the excess stem with side cutters leaving approximately 5mm of the tail behind.

WARNING: Flooding may occur if the tails of the valves have not been fully pulled through. Check that barb has engaged on inside of case.



2. Orientate the Exhaust Gate (14) with the straight edge to the open side (top) of the Case (1). (Note that the Exhaust Gate is not symmetrical). Insert the two tabs into the bottom side of the case first, then, whilst squeezing in the sides, clip in the top two tabs.

CAUTION: Care should be taken. Damage can occur to the exhaust gate if it is not fit correctly.



NOTE: Check sides have clipped in properly. If they have not then gate must be removed (according to Disassembly Procedure 13) then re-installed

Assembling and fitting valve assembly

3. Install a new, lubricated 'O' Ring (4) onto the Spring Carrier (3).



CAUTION: Damage to 'O' ring can occur if placed inside the shuttle valve and not installed onto the spring carrier first as shown above.

4. Press a new Rubber Seating (7) into the front of the Shuttle Valve (6).

NOTE: Ensure Rubber Seating has been fitted flush with Shuttle Valve.



5. Fit the Valve Spring (5) over the Spring Carrier (3). Carefully guide the stem of the Shuttle Valve (6) over the Spring Carrier (3).



6. Carefully insert the above Shuttle Valve assembly into the Spindle Body (2).



CAUTION: Ensure that lever is not twisted and that legs are parallel. Lever should appear as that shown on the left, not as shown on the right. If necessary, gently squeeze legs together to straighten.

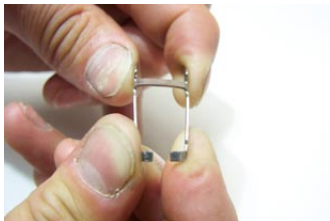

7. Whilst pressing in Shuttle Valve (6) with finger, insert Lever (8) by sliding feet into holes one at a time.



-  **NOTE:** Lever should face away from spindle opening as shown below.



8. Install Spindle Assembly (2-8) into Case (1).

-  **NOTE:** Ensure that the Lever has a full range of movement and does not catch on either the Spindle Body or the Case.



9. Install new lubricated 'O' Rings (10 & 11) onto the Valve Seat (9) and the Inlet Fitting (12).



10. Install the Valve Seat (9) into the Inlet Fitting (12), **screwing anti-clockwise** with a 5mm Allen Key until it stops.



CAUTION: Do not tighten



11. Whilst holding the Spindle Assembly (2-8) in place, screw the Inlet Fitting (12) into the Case using a torque wrench with a 19mm adapter or socket. Tighten to 5 Nm.



12. **By turning clockwise**, screw in the Valve Seat (9) until the Lever (8) drops.

 **NOTE:** Top of Lever should be 2mm below the top of the Case, although the correct lever height can be checked in step 15



Fitting Diaphragm

13. Position the Diaphragm (15) in the Case (1), followed by the Friction Ring (16). Work edges of Friction Ring into place with finger so that the Diaphragm sits evenly in the Case.



14. Screw in the Inner Locking Ring (17) using Egress Locking Ring Tool (AT62) and tighten.



 **CAUTION:** Ensure Diaphragm is seated correctly and not creased. Creasing may be caused by excessive tightening. Carry out suction test by holding thumb over Inlet Fitting (12) to seal and trying to breathe through mouthpiece outlet port. No air should be drawn in.

Correct Lever Height Check

15. At this stage, it is important to check the correct lever height setting. To do this, connect the Egress second stage to a medium pressure air supply of 9.5 (±0.5) bar and pressurise the regulator.

- 15a. With the regulator pressurised, locate and press the Egress Locking Ring Tool (AT62) onto the top of the Case as shown right. There **should** be a highly audible flow of air through the mouthpiece outlet port. If there is no air flow, the lever is set too low.



- 15b. With the same tool used the opposite way round, and located into the Inner Locking Ring as if tightening in step 14, there **should not** be an audible flow of air. If there is an audible flow of air, the lever is set too high.



 **CAUTION:** Any adjustment should only take place when regulator is un-pressurised.

16. Install Front Cover (18) and screw in Front Locking Ring (19). Tighten using other side of Egress Locking Ring Tool (AT62.)

 **NOTE:** Ensure that the ribs on the Front Locking Ring are aligned correctly with those on the Front Cover when tightening using locking ring tool.



Fitting hose and mouthpiece

17. Install new, lubricated 'O' Rings to the medium pressure hose; 'O' Ring AP1154 to the swivel end and AP1409 to the male end.



18. Screw the hose onto the Egress. Using a torque wrench with an 1¹/₁₆" adapter, tighten the hose to 5 Nm.



19. Fit the Mouthpiece (21) over the boss on the Case (1). At the base of the Mouthpiece is a groove for the Zip Tie (22). Wrap the Zip Tie around the Mouthpiece so that the buckle points towards the exhaust. Tighten the Zip Tie and snip the excess strap with side cutters.



WARNING: Ensure that the Mouthpiece is properly secured on the boss.

FINAL TESTING

Second Stage Opening Effort Test

1. Connect the first stage regulator to a calibrated test bench and pressurise the system to 200 (±10) bar. Slowly open the flowmeter control knob (start vacuum) while watching both the magnahelic gauge and the intermediate pressure gauge.
2. When the intermediate pressure begins to drop, indicating the second-stage valve is open, the magnahelic gauge should indicate an opening effort of +1.5" to +2.2". If the reading exceeds these specifications, refer to "Table 1 - Troubleshooting" for corrective actions.

External Leak Test

1. After disconnecting the regulator from the flow bench, connect it to a scuba cylinder filled to approximately 200 bar. Open the cylinder valve to repressurise the regulator, and submerge the entire system in a test tank of clean water.
2. Observe any bubbles arising from the submerged regulator over a one minute period. The recommended time is necessary due to slower bubble formation that occurs in smaller leaks. Bubbles indicate a leak, which requires the system to be disassembled at the source to check sealing surfaces, assembly sequence and component positioning in order to correct the problem(s).



NOTE: Extremely small leaks may be better detected by applying a soap solution or Snoop™ to the leak area. Bubble streams will indicate the source of the leak. Before disassembling to correct any leaks, rinse the entire regulator thoroughly with fresh water and blow out all residual moisture with filtered, low-pressure air. Disassemble and remedy the problem, referring to "Table 1 - Troubleshooting."

Subjective Breathing Test

1. Depress the Front Cover fully to ensure that an adequate volume of air needed to clear the second stage flows through the mouthpiece. Then, inhale slowly but deeply from the mouthpiece. A properly serviced and adjusted regulator should deliver air upon deep inhalation without excessive inhalation effort, freeflow, or "fluttering" of the second-stage diaphragm. When exhaling, there should be no fluttering or sticking of the exhalation valve. If any of these problems occur, refer to "Table 1 - Troubleshooting".

This Ends Reassembly



Table 1 - Troubleshooting Guide

SYMPTOM	POSSIBLE CAUSE	TREATMENT
Leakage or freeflow from Egress	1. Excessively high first-stage intermediate pressure.	1. Refer to first-stage Troubleshooting Guide.
	2. Rubber Seating (7) damaged or worn.	2. Replace Rubber Seating.
	3. Valve Seat (9) adjusted incorrectly, Lever (8) set too high.	3. Reset Valve Seat preliminary settings, and repeat Adjustment Procedures.
	4. Lever (8) bent.	4. Replace Lever.
	5. Valve Seat (9) sealing surface damaged.	5. Replace Valve Seat.
	6. Valve Spring (5) damaged.	6. Replace Spring.
	7. Spring Carrier 'O' Ring (4) damaged.	7. Replace 'O' Ring.
	8. Shuttle Valve (6) bore damaged.	8. Replace Shuttle Valve.
Low purge or excessive work of breathing (full cylinder)	1. Low first-stage intermediate pressure.	1. Refer to first-stage Troubleshooting Guide.
	2. Valve Seat (9) adjusted incorrectly, Lever (8) set too low.	2. Reset Valve Seat to preliminary setting and repeat Assembly Procedure 12.
	3. Intermediate pressure hose clogged or obstructed.	3. Clean or replace Hose.
	4. Lever (8) bent or catching on Spindle Body (2).	4. Replace Lever.
Water entering Egress	1. Mouthpiece (21) damaged or incorrectly fitted.	1. Replace or re-fit Mouthpiece as appropriate.
	2. Diaphragm (15) damaged.	2. Replace Diaphragm.
	3. Diaphragm (15) improperly seated in Case (1).	3. Remove Front Cover (18) and Inner Locking Ring (17) properly reassemble Friction Ring (16) with Diaphragm (check for distortion).
	4. Exhaust Valve(s) (13) damaged.	4. Replace Exhaust Valve(s).
	5. Case (1) damaged. (Check exhaust valve seating surface.)	5. Disassemble and replace Case.
	6. Inlet Fitting 'O' Ring (11) damaged.	6. Replace 'O' Ring.

Table 2 - Recommended Tool List

PART NO.	DESCRIPTION	APPLICATION
AP0430	I.P. test gauge	Intermediate pressure testing
AT54	'O' Ring removal pick	'O' Ring removal
AT62	Egress Locking Ring Tool	Front Cover, Inner Locking Ring removal and installation
n/a	Torque wrench, Nm or lbf/ft	Inlet Fitting, Hose
n/a	11/16" adapter for torque wrench	Hose
AT34	11/16" spanner	Hose
AT37	5mm Allen key	Valve Seat
AT33	19mm spanner	Inlet Fitting
n/a	19mm adapter for torque wrench	Inlet Fitting
n/a	Side cutters	Zip Tie, Exhaust Valves
n/a	3mm Screwdriver	Exhaust Gate removal

Table 3 - Recommended Lubricants & Cleaners

LUBRICANT / CLEANER	APPLICATION	SOURCE
Christo-Lube® MCG-111 (Lubricant)	All 'O' Ring seals	Apeks Marine Equipment Ltd PN AP1495, or Lubrication Technologies 310 Morton Street Jackson, OH 45640, USA (800) 477-8704
 CAUTION: Silicone rubber requires no lubrication or preservative treatment. DO NOT apply grease or spray to silicone rubber parts (eg. Diaphragm, Exhaust Valves.) Doing so may cause a chemical breakdown and premature deterioration of the material.		
Biox (Cleaning agent)	Biological immersion fluid for reusable stainless steel and brass parts.	Solent Divers Ltd 122-128 Lake Rd, Portsmouth, Hants, PO1 4HH
White distilled vinegar (100 gr.) (Cleaning agent)	Acid bath for reusable stainless steel and brass parts.	"Household" grade
 CAUTION: Do not use muriatic acid for the cleaning of any parts. Even if strongly diluted, muriatic acid can harm chrome plating and may leave a residue that is harmful to 'O' Ring seals and other parts		
Liquid dishwashing detergent diluted with warm water (Cleaning agent)	Degreaser for brass and stainless steel parts; general cleaning solution for plastic and rubber	"Household" grade

Cleaning & Lubrication Procedure

General Cleaning of all Parts

1. Place all components in an ultrasonic cleaning bath containing an appropriate cleaning solution, such as Biox.
2. The components should be cleaned for 6 minutes, depending upon their condition. Longer cleaning times may be used if required.
3. Rinse the components in warm fresh water.
4. The components should then be blown dry or left to dry naturally.

Lubrication and Dressing

All 'O' Rings should be lubricated with Christo-Lube[®] MCG-111. Dress the 'O' Rings with a very light film of grease, and remove any visible excess by running the 'O' Ring between thumb and forefinger. Avoid applying excessive amounts of Christo-Lube grease, as this will attract particulate matter that may cause damage to the 'O' Ring.

Nitrox

When it comes to issues of nitrox safety and compatibility, the concerns lie primarily with the first stage as it is subjected to high inlet pressures. High inlet pressures lead to adiabatic compression or heating of the gas. As they leave the factory, standard Apeks regulators are suitable for use with oxygen enriched gases (i.e. nitrox, etc.) providing the oxygen content does NOT EXCEED 40% (EAN40).

Any Apeks regulator, when properly cleaned, lubricated and assembled, is authorised for use with enriched air nitrox (EAN) up to 100% (EAN100). It is authorised because it has undergone adiabatic compression testing and the authorised service kit components and lubricants are compatible in elevated oxygen environments. During cleaning, a mild detergent is used to remove condensed hydrocarbons (compressor oils) from the inside passageways of the first stage. For the first stage to remain EAN100 compatible, only use hyperfiltered compressed gas (hydrocarbons < 0.1 mg/m³). Ordinary compressed breathing air to BS EN 12021:1999 does not meet this criteria. Once ordinary breathing air is used, the first stage is no longer EAN100 compatible until it is cleaned and serviced again.

Although regulator second stage components are not exposed to high pressure EAN, Apeks recommends that the same cleaning procedures be followed for the complete regulator. This prevents the possibility of cross contamination and guarantees the cleanliness of the entire regulator.

 **WARNING:** Please check the regulations regarding Nitrox in your particular country as this may differ from Apeks standard policy.

Table 4 - Torque Specifications

PART NUMBER	DESCRIPTION / KEY NUMBER	TORQUE
AP7561	Inlet Fitting (12)	5 Nm / 3.7 lbf/ft
AP0206	Hose	5 Nm / 3.7 lbf/ft

Table 5 - Test Bench Specifications

TEST	CONDITION	ACCEPTABLE RANGE
Opening Effort	High Pressure > 50 bar gauge Medium pressure 9.5±0.5 bar	+1.5 to +2.2 in. H ₂ O
External Leak	High Pressure > 50 bar gauge Medium Pressure 9.5±0.5 bar	No Leaks allowed

Exploded Parts Diagram

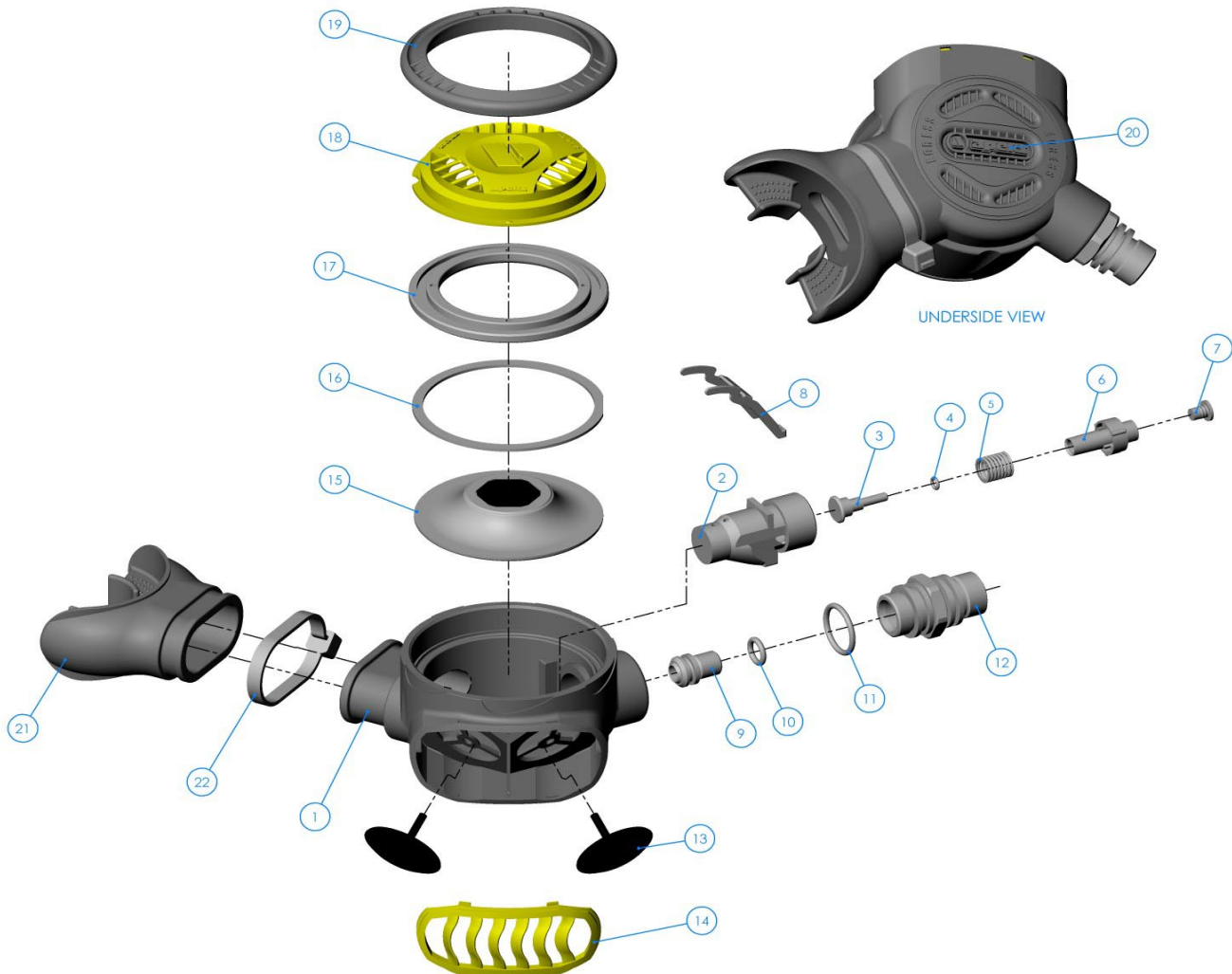

* All marked items must be replaced when serviced.

1	AP7550	Egress Case	12	AP7561	Egress Inlet Fitting
2	AP7560	Egress Spindle Body	13	AP7552	Egress Exhaust Valves
3	AP7562	Egress Spring Carrier	14	AP7558	Egress Exhaust Gate
4*	AP5711	'O' Ring	15	AP7553	Egress Diaphragm
5	AP2021	Valve Spring	16	AP7554	Egress Friction Ring
6	AP5707	Shuttle Valve	17	APF116923	Inner Locking Ring
7*	AP2034	Rubber Seating	18	AP7556	Egress Front Cover
8	AP2035	Lever	19	AP7557	Egress Front Locking Ring
9	AP7563	Egress Valve Seat	20	AP7551	Egress Decal
10*	AP1154	'O' Ring	21	AP1434	Evoprene Mouthpiece
11*	AP1267	'O' Ring	22	AP1677	Zip Tie

Notes



EGRESS SECOND STAGE REGULATOR

MAINTENANCE MANUAL

FOR

AUTHORISED TECHNICIANS

Apeks Marine Equipment Ltd
Neptune Way, Blackburn, Lancs, England, BB1 2BT